

Rock lobster

Recreational fishing guide 2026



A current licence is required to fish for any species of rock lobster

Please note:

- A maximum of 2 floats may be attached to your pot.
- Do not pull a pot without surface floats under any circumstances. Please report unmarked gear via FishWatch 1800 815 507.
- Weighted pot rope arrangements required from 1 April to 31 October in any year.
- Never pull another person's pots.
- Information about sea lion exclusion devices (SLEDs) included.

Contents

Recreational fishing rules	1
Licences.....	1
Fishing season and times.....	1
Legal size and statewide catch limits	3
Correctly measuring rock lobsters	4
Bag, boat and size limits explained	5
Totally protected lobsters	7
Identifying berried and tarspot lobsters ...	8
Fishing for lobsters	9
Pot specifications.....	10
Float requirements	13
Rope coiling	16
Sea lion exclusion devices (SLEDs).....	17
Plastic bait bands.....	21
Lobsters you keep	22
Catch care guide for lobsters	23
Releasing lobsters	23
Keeping lobsters for consumption	24
Marine conservation areas	25
Other rock lobster fishing closures	26
Marine fauna sightings app	27
Tagged lobsters	28
Penalties for illegal fishing.....	29
FishWatch	29

Important disclaimer

The Chief Executive Officer of the Department of Primary Industries and Regional Development and the State of Western Australia accept no liability whatsoever by reason of negligence or otherwise arising from the use or release of this information or any part of it.

This publication is to provide assistance or information. It is only a guide and does not replace the *Fish Resources Management Act 1994* or the *Fish Resources Management Regulations 1995*. It cannot be used as a defence in a court of law. The information provided is current at the date of printing but may be subject to change. For the most up-to-date information on fishing and full details of legislation contact your local DPIRD office or visit dpiird.wa.gov.au

Copyright © State of Western Australia (Department of Primary Industries and Regional Development), 2026



Recreational fishing rules

Licences

You must have a rock lobster licence to fish for any species of rock lobster and produce it when requested by a DPIRD Fisheries and Marine Officer.

Apply for a new licence, or renew an existing one online through the DPIRD website or DoTDirect. Alternatively, application forms are available from select DPIRD offices and our website.

You cannot sell, barter or exchange recreationally caught lobsters for goods or services.

Recreational fishers on a fishing tour are not required to hold a rock lobster licence to possess rock lobster.

Fishing season and times

Statewide:

All species of lobster may be taken all year.

Night fishing ban:





A seasonal night fishing ban applies southwards of the North West Cape. A person must not pull pots or fish for rock lobster by diving during the below dates and times:

15 October – 31 March, 7:30 pm – 4:30 am

1 April – 14 October, 6:00 pm – 6:00 am

Legal size and statewide catch limits

Size limits apply to rock lobster species. You must return a rock lobster to the water immediately if it is under legal size.

Species	Minimum legal carapace length	Individual daily bag limit	Mixed species bag limit	Boat limit	Possession limit*
 <p>Western rock lobster (<i>Panulirus cygnus</i>) Identifiable by a single white dot on the outside (lateral) edge of each tail segment</p>	76 mm	8	8 of which no more than 4 can be tropical rock lobsters	24 of which no more than 12 may be tropical rock lobsters (At least 3 people with licence must be on board)	24 All species combined
 <p>Southern rock lobster (<i>Jasus edwardsii</i>) Identifiable by a single spine between and just forward of their eyes</p>	98.5 mm	8			
 <p>Tropical rock lobsters: Ornate (<i>Panulirus ornatus</i>)</p>	76 mm	4			
 <p>Tropical rock lobsters: Painted (<i>Panulirus versicolor</i>)</p>	76 mm	4			

*Anywhere on the landward side of the high-water mark.

Correctly measuring rock lobsters

Western and tropical rock lobster

Place the end of a gauge over the ridge between the two spikes at the front of the rock lobster's head (A) and the other end of the gauge over the back of the carapace (B).

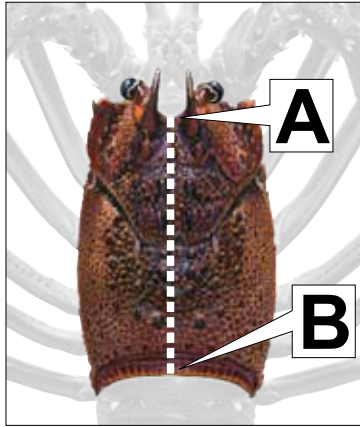

Southern rock lobster

Place the end of a gauge from the notch in between the two antennae (C) to the back of the carapace (D) and the median line of the lobster's body.

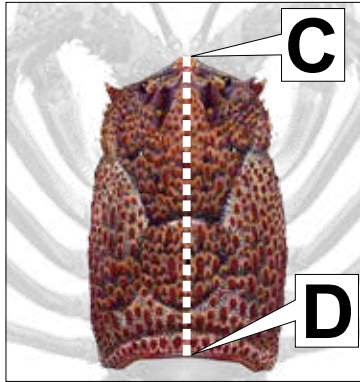

Bag, boat and size limits explained

Mixed species daily bag limit



This is the combined maximum number of rock lobster of any species that a fisher may take or bring on to land in any 24-hour period (from midnight to midnight). For example, rock lobster has a total mixed daily bag limit of **8** rock lobster.

Note: Within the mixed daily bag limit, you cannot exceed the stated individual species limit (see below). For example, you may only take a maximum of **4** tropical rock lobster per day.

Individual species daily bag limit

This is the maximum number of an individual species you may take within your total mixed species daily bag limit.

Boat limit

A boat limit is the maximum number of fish of a species or group of species that may be on a boat or attached to a boat (including tender vessels) at any one time. This limit applies regardless of how long the vessel is at sea.

The boat limit for rock lobster is calculated by multiplying the relevant daily bag limit by the number of licensed fishers on the boat, up to the maximum boat limit. The master of the boat must ensure these rules are followed.

For example, the boat limit for western rock lobsters is **8** when there is one licensed fisher on board, **16** when there are **2** licensed fishers on board, and up to a maximum of **24** when there are **3** or more licensed fishers on board the boat, regardless of how long the vessel is at sea.

Possession limits and transporting lobster

A possession limit is the maximum quantity of rock lobster that a person may have in their control/ownership. Possession limits apply to rock lobster. Rock lobster must not be transported unaccompanied, such as by a courier service.

You can only be in possession of rock lobster tails on the landward side of the high-water mark. Rock lobster must be in whole form when on a vessel unless it is being prepared for immediate consumption, or on a commercial passenger boat, such as a ferry.



Totally protected lobsters

Lobsters are totally protected at some stages in their lifecycle. When lobsters are protected, you may not take them, have them in your possession, or bring them into the State or into WA waters.

You are legally required to return undersize, berried and/or tarspot lobsters to the water from which they were taken, before the next pot is pulled and before you catch another lobster when diving.

Berried females

Any species of lobster that is carrying eggs (berried) is protected.

Tarspot females

Western rock lobsters with a tarspot are protected between Windy Harbour and North West Cape.

When lobsters mate, the male deposits a packet of sperm, known as a tarspot, under the carapace between the back legs of the female.

When it is fresh, the tarspot is white and sticky. It then gradually becomes darker as it hardens, a few hours after mating. During spawning, the female releases sperm from the tarspot to fertilise her eggs.

Identifying berried and tarspot lobsters



Berried female



Female lobsters with tarspot (sperm packet) under carapace between the back legs.

Photo: Tony Antenucci, skipper of C-Ray

Fishing for lobsters

Diving

Divers may only catch rock lobster by hand, a hand-held snare or a blunt crook.

Spears, nets and other similar items that can damage rock lobster are illegal.

Divers should measure and count rock lobsters in the water and release any undersized or tarspot/berried females before catching the next rock lobster.

Illegal baits

You may not fish for rock lobster using any rock lobster or abalone material. The use of demersal scalefish species as bait is prohibited in the West Coast bioregion.

Pot limits

No more than **2** rock lobster pots per licence holder. A maximum of **6** pots may be pulled when there are **3** or more licensed fishers on board per boat trip.

No more than **6** pots may be carried on a boat at any time.

Pots must be set and pulled by the licence holder.

Pulling and setting someone else's pot is illegal unless that person is on board the boat. This includes for the purpose of re-baiting the pot. Even if you have permission from a friend or family member to pull their pot, it is still illegal.

It is illegal to interfere with someone else's

float, rope or pot. It is also illegal to remove someone else's float from a pot and replace it with your own.

If you locate a pot that appears to be abandoned or a pot rope with no floats attached, do not touch the pot and report the GPS location of the pot via **FishWatch** on **1800 815 507**.

Sharing pots

Two licensed fishers are permitted to share rock lobster pots. Each licensed fisher must have their own separate float with their issued personal gear identification (ID number) marked on the float. No more than **2** floats, each with only one gear ID number, must be attached.

A maximum of **2** pots is allowed when sharing with another person. Pots can only be shared with one other person.

Fishers are not permitted to bring home lobsters on behalf of the person who shares their pot and may only take and land their own bag limit.

Pot specifications

Various types of pots – batten, beehive (cane) and other pots (such as moulded plastic pots) – can be used. Before using pots, check that they conform to standards set out in the *Fish Resources Management Regulations 1995*.

A pot must not exceed 1,000 mm in diameter or width at its widest point and 500 mm in height.

Entrance and escape gaps

Pots must have only 1 entrance. The neck must be rigid and at least 160 mm wide.

Pots must not have any internal partitions or chambers. Escape gaps and the neck must not be obstructed with the exception of an approved SLED.

North of North West Cape, pots do not require escape gaps. Between North West Cape and Cape Leeuwin, pots must have at least **3 escape gaps**. In the waters south and east of Cape Leeuwin, pots must have at least **1 escape gap**.

Escape gaps must be as far away as practical from the hauling rope attachment points and no more than 110 mm above the base of the pot. They must not be obstructed by ballast, rope or anything else. Gaps must not be between the hauling rope attachment points on any type of pot.

Each escape gap must be a minimum of 54 mm high and 305 mm wide and made of rigid material that can't reduce the internal measurements of the escape gap.

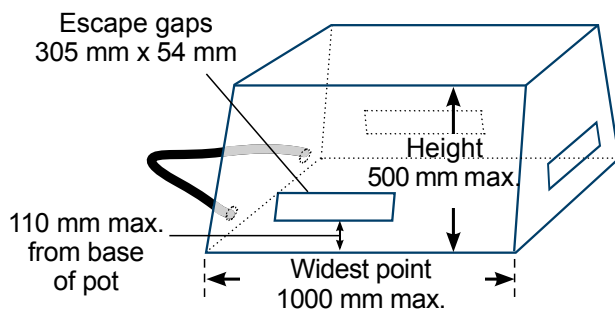

To help prevent pot theft and illegal pot pulling, and to help us identify lost or stolen pots, we encourage fishers to engrave their gear identification number into their own pots – if possible, on the frame and on the end where the hauling ropes are attached (for example, see the batten pot image below).



Float requirements

Surface floats must be fitted to every pot rope. They must be at least 150 mm in diameter and stamped or branded with the licence holder's gear ID number, with lettering 60 mm high and at least 10 mm wide.

You may only have **2** floats attached to your pot at any time, regardless of the length of rope you are fishing with or if you are pot sharing. Please note: the use of pool noodles is not permitted.

Gear identification numbers

You are required to display your gear identification number, issued with your licence, on all floats. Gear identification numbers are based on the first initial of both your given and surname, and the month and year of your date of birth. For example if Jenny Saltwater was born on 4/11/1991, her gear ID number would be JS1191. You may not have your gear ID number on more than **2** pots.

Rope requirements

Weighted rope requirements apply to recreational fishers from 1 April to 31 October in any year (during whale migration season). When more than 20 m of rope length (combined pot line and float rig) is attached to a pot, fishers must ensure that the top half of the pot line rope is hung vertically in the water column (see diagram on page 14).

'Pot line' means the length of rope between the first surface float and the bridle. 'Float rig' means the rope on the surface of the water connected to the first surface float and the last surface float, including any rope that extends beyond the last surface float (see diagram below).

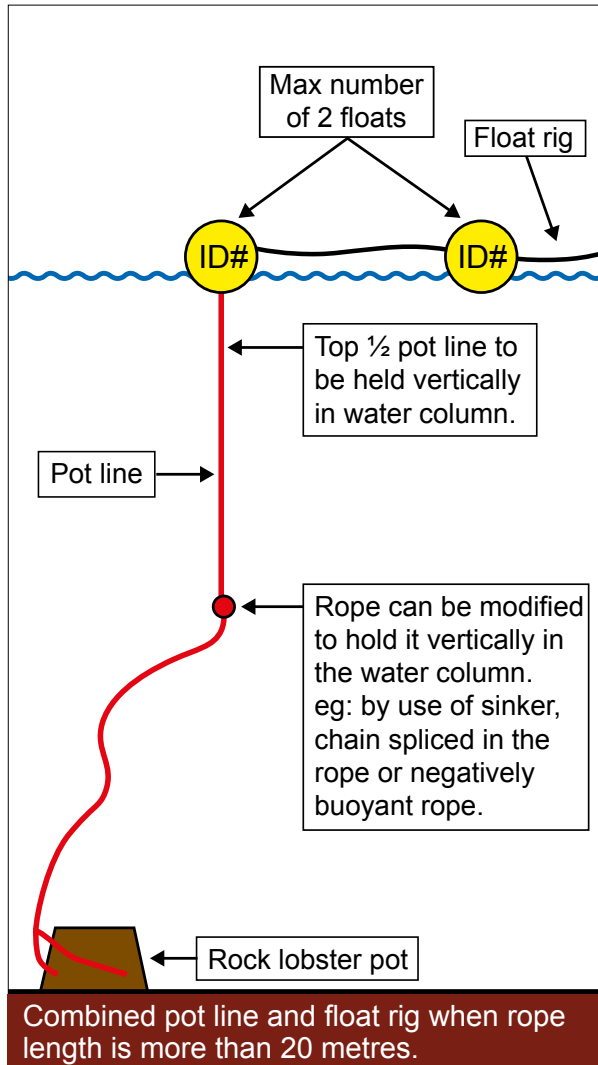

Reducing the amount of rope on the surface of the water will minimise the risk of gear entanglements with migrating humpback whales during the winter months and will reduce the loss of fishing gear from entanglement with other fishing boats.

Suggested methods for hanging pot rope vertically in the water column:

- Attach a weight to the rope, half way down the pot line.
- Replace the top half of the pot line rope with negatively buoyant rope.

Ways to safely and efficiently weight the rope:

- Attach a 'shark clip' to a snapper sinker and attach to the pot line rope.
- Attach (splice) a small piece of rope with sinkers attached, into the main pot line rope (see below).



Shark clips



Snapper sinker



Splice attached to main pot line

It is recommended that fishers use at least a 16 ounce (~450 gram) weight to ensure the rope remains vertical in the water column.

Rope coiling

Coiling and tying up excess rope on the surface of the water is called 'dog boning' and is permitted although not encouraged due to the risk of rope coming undone or lengthening if not secured correctly.

If fishers choose to dog bone their rope, they must ensure that the dog bone or coiled rope is held securely so the combined pot and float line rope does not exceed 20 m in length.

It is the fisher's responsibility to ensure the dog bone or rope coil cannot come undone. Additional securing of the rope coil is recommended when using this method.

Sea lion exclusion devices (SLEDs)

SLEDs are required to be fitted to pots at certain locations to prevent sea lions being caught. SLEDs are mandatory for fishers who use lobster pots between South Rocks (south of Wedge Island) and Freshwater Point, south of Dongara.

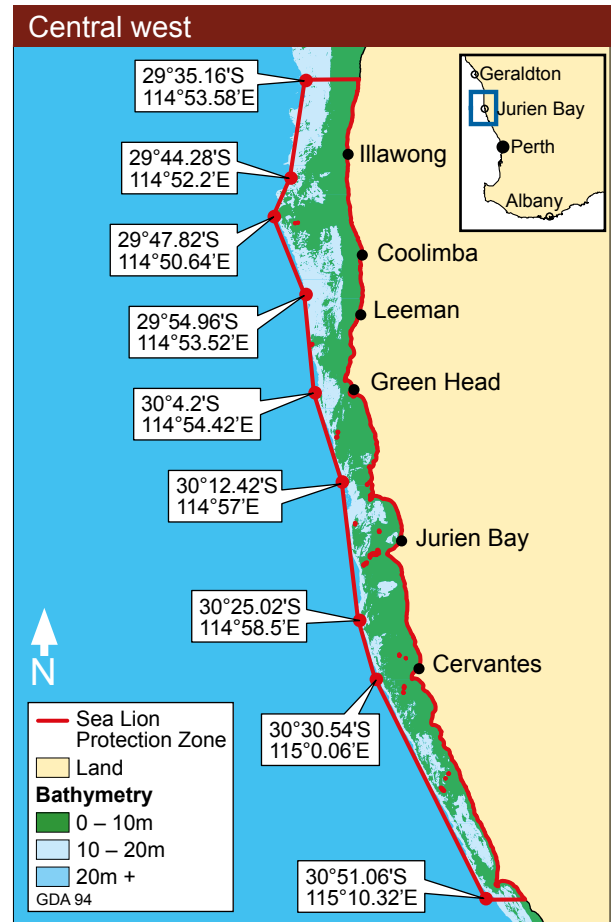

SLEDs are also mandatory in two areas of the Abrolhos Islands – the Easter and Pelsaert groups of islands.



Abrolhos Islands

Easter group

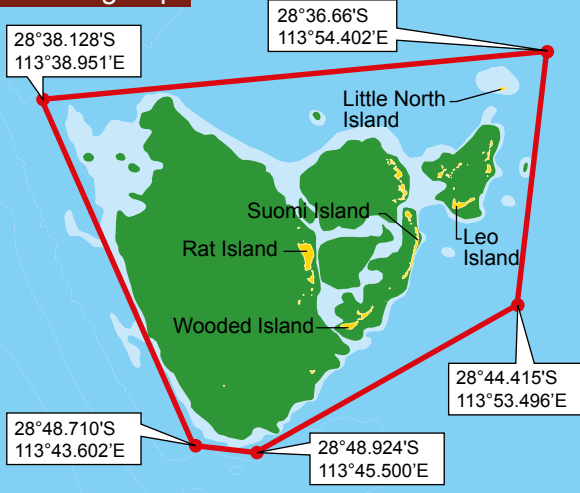

Pelsaert group

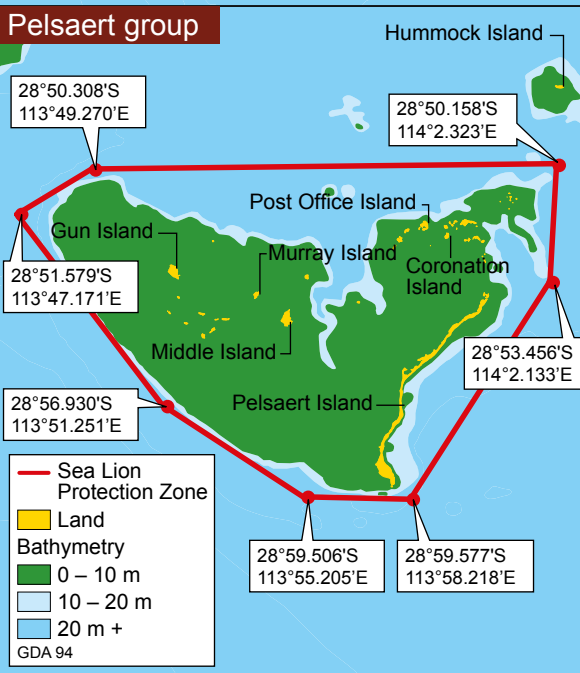

A SLED is fitted by fixing a piece of rigid, non-flexible material across the top of the neck that ensures that the gap from the edge of the external SLED to either side of the top of the neck is no greater than 132 mm.



Rectangular and square neck pots

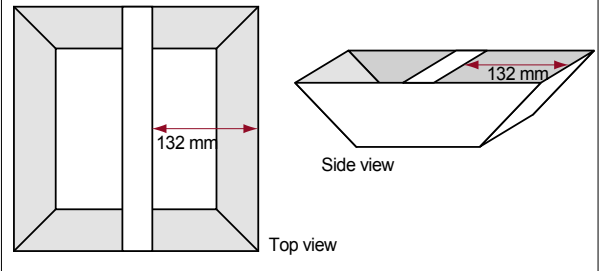

Round neck pots

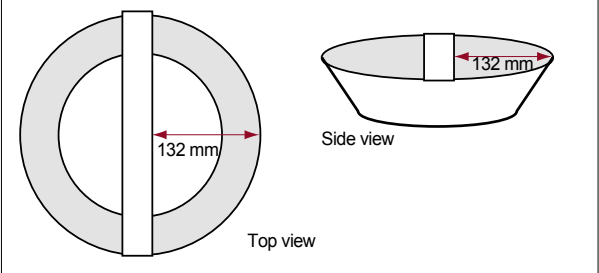

Alternatively a SLED can be fitted by the fixing of a rigid, non-flexible piece of material rising vertically from the base of the pot to a height that ensures the diagonal distance to the neck from the top centre of the internal SLED is no greater than 132 mm. The diagonal distance is to be measured to the edge of the neck in any direction in a round neck pot, and to the midpoint of the four sides in a square or rectangular neck pot.

Rectangular and square neck pots

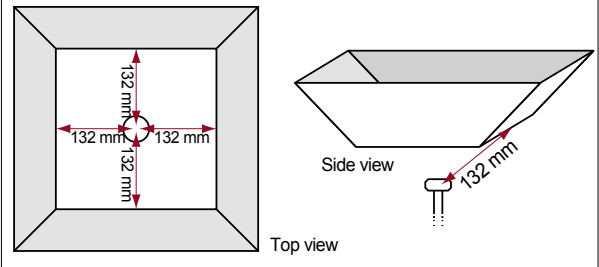

Round neck pots

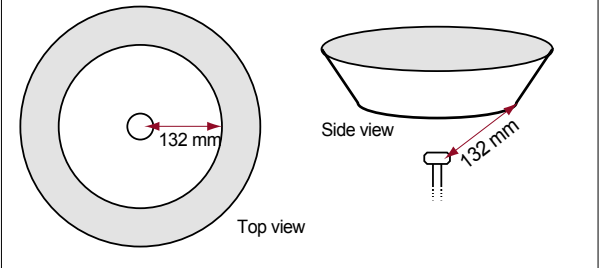

This internal SLED juts vertically from the pot's base so the sea lion can't get in.

Dimensions of internal SLED

The internal SLED must be a minimum of 10 mm in diameter and the top of the internal SLED must be a minimum of 10 mm and a maximum of 30 mm in diameter.

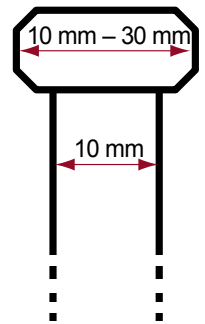

Plastic bait bands

Possessing plastic bait bands at sea is prohibited on commercial and recreational fishing boats in WA. The bands pose a risk to marine life through entanglement.

Lobsters you keep

Tail clipping

If a lobster is kept, you must clip the central flap on its tail fan, removing at least the bottom half of it, or punch a circular hole of no less than 10 mm in diameter in the central segment of the tail fan within 5 minutes of the lobster being brought to the boat or land where a boat is not used.

This is done to identify it as a recreationally caught lobster, which can't be sold.

At the end of your fishing activity you:

- must not have any Totally Protected Fish (for example undersize and/or tarspot etc)
- must not have more than the bag limit or boat limit
- must have tail clipped all retained lobsters.



Catch care guide for lobsters

Releasing lobsters

Poor handling of lobsters can cause injuries to the carapace or loss of appendages, which can affect individual growth and increase vulnerability to predation.

Lobsters exposed to air for more than 5 minutes and then released descend slowly to the seafloor, increasing their risk of predation from fish and octopus. By releasing non-retained rock lobsters quickly and carefully, you maximise their chances of survival.

Return lobsters to the same area you pulled the pot to ensure they are within their home grounds and not disorientated.

Aim to place them over reef or seaweed to ensure they have a safe refuge to recover. By doing this, we can increase survival of lobsters and improve future catches.

Keeping lobsters for consumption

Lobsters can be humanely despatched by placing them in a freezer, or immersing in chilled water or on ice for up to 20 minutes.

Lobsters have a chain of nerve centres running down their central length. It is recommended that for processing, splitting the lobster along the midline from head to tail with a large, sharp knife is the most humane method of despatch.



Marine conservation areas

Rock lobster fishing is restricted within some marine conservation areas such as State Marine Parks, Commonwealth Marine Parks and Fish Habitat Protection Areas.

State and Commonwealth Marine Parks have 'no take' sanctuary zones or National Park Zones that are closed to all fishing. Fishing is also prohibited within certain areas of Fish Habitat Protection Areas.

For specific information on the marine conservation areas and restrictions that may apply to rock lobster fishing please visit the following websites:

State Marine Parks

- The Department of Biodiversity, Conservation and Attractions website dbca.wa.gov.au; or
- The Department of Primary Industries and Regional Development's recreational fishing rules website rules.fish.wa.gov.au

Commonwealth Marine Parks

- Parks Australia website parksaustralia.gov.au

Fish Habitat Protection Areas

- The Department of Primary Industries and Regional Development's recreational fishing rules website rules.fish.wa.gov.au

Other rock lobster fishing closures

Point Samson

Fishing for rock lobster in Point Samson is not permitted.

Rottneest Island

Fishing is prohibited in the five conservation areas – Parker Point, Thomson Bay, Armstrong Bay, Green Island and West End.

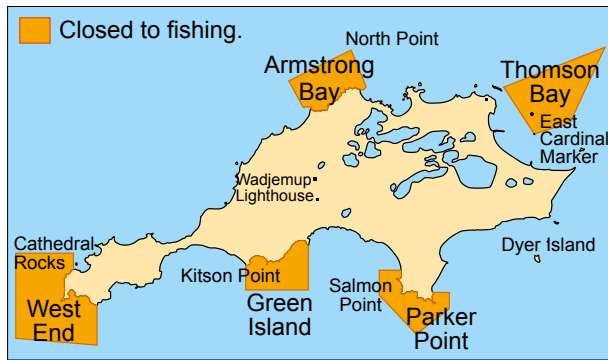

Research areas – closed to recreational rock lobster fishing

Jurien Bay Research Area (zone within the Jurien Bay Marine Park)

Lobster fishing is prohibited in the waters between Boullanger Island to Osprey and Whitlock islets.

Seven Mile Beach – Dongara

Lobster fishing is prohibited within the research area.

Dive wrecks

All fishing is prohibited within the stated areas at the following wreck sites:

- **HMAS Perth:** within 250 m.
 - **HMAS Swan:** within 200 m.
 - **Kunmunya and Samson II:** within 500 m.
 - **Lena:** within 400 m.
 - **Sanko Harvest:** within 500 m.
 - **Saxon Ranger and South Tomi:** within the defined areas
- dpird.wa.gov.au/individuals/recreational-fishing/recreational-fishing-rules/west-coast-bioregion/

Marine fauna sightings app



The Marine Fauna Sightings app is designed to allow fishers, citizen scientists and all water users to submit their sightings of marine fauna off the WA coast.

Reporting sightings of marine fauna give us a better understanding of where and when different species (whales, dolphins, turtles, seals and sea lions, dugongs, and sea snakes) move along our coast, and their behaviour patterns. This information assists us in protecting important species that frequent and migrate through our coastal waters and help us to provide better management information to the fishing industry.

Learn more about the app.



Tagged lobsters

Scientists use yellow 'spaghetti' tags to collect data about lobster movements, growth rates, abundance and catch rates.



If you catch a tagged lobster, write down the tag number, lobster size (carapace length), sex, date, location (GPS co-ordinates if possible) and depth at which it was caught. Also record whether it was carrying eggs or had a tarspot and whether it was kept or released.

If the lobster is legal to take, you may keep it. If it is not legal to take (undersize or berried) return it to the water with the tag still attached.

Report tagged lobsters to Ben Hebiton on **08 9203 0111** or email **lobster.tag@dpiird.wa.gov.au**. iPhone users can submit the information using our free FISHTAGWA app.

Penalties for illegal fishing

Please note that **penalties apply** for fishing offences. All fishing may be subject to surveillance by DPIRD Fisheries and Marine Officers.

Taking undersize rock lobster or having more than your possession limit can attract fines as high as \$5,000 for an individual plus up to 10 times the prescribed value of the species.

Interfering with another person's fishing gear or catch, selling recreationally caught fish and other similar offences can result in penalties of up to \$400,000, imprisonment for four years and loss of boats, vehicles and equipment. Offenders may also lose the privilege of engaging in a licensed fishing activity.

FishWatch

The FishWatch phone line provides the quickest and most efficient way to report sightings or evidence of:

- illegal fishing
- aquatic pests and diseases; and
- fish kills.

You can also submit reports online to **crimestopperswa.com.au/organisation-report/fishwatch/**

Reports made to Crimestoppers are not monitored outside normal working hours or on weekends.



Report shark sightings
to Water Police on

08 9442 8600

Download the
SharkSmart WA app



A030-25 DEC 2025

SHARKSMART.COM.AU

Join Recfishwest's Cast of Thousands!



Recfishwest represents
WA's 700,000 recfishers'
rights and interests and
champion sustainability,
safety, research and the
environment. Best of all we
help keep the fun in fishing!



**JOIN OUR CAST OF THOUSANDS TODAY AS A
RECFISHWEST MEMBER AND HELP US MAKE FISHING
BETTER!**



Scan the QR code or visit Recfishwest.org.au
for more information!



www.Recfishwest.org.au

Hook up to the rec fishing rules

It's easy to keep up to date with West-
ern Australia's recreational fishing rules.
Whether it's for bag and size limits,
seasonal closures or licences, all the
rules are at your fingertips.



Go to rules.fish.wa.gov.au for
rules covering more than 180
fish species. Use the interactive
maps to discover information
about marine protected
areas and common
species by region.



The free Recfishwest app
provides access to the rules
even if you're out of phone
range and has an easy fish
identification feature.



Grab a copy or
download from
[dpird.wa.gov.au/
rec-fishing-guides](http://dpird.wa.gov.au/rec-fishing-guides)



Contact us

1300 374 731 (1300 DPIRD1)

enquiries@dpird.wa.gov.au

Albany Office

444 Albany Highway,
Albany WA 6330
08 9845 7400

Broome Office

401 Port Drive,
Broome WA 6725
08 9193 8600

Busselton Office

48A Bussell Highway,
Busselton WA 6280
08 9752 2152

Carnarvon Office

262 South River Road,
Carnarvon WA 6701
08 9956 3333

Fremantle Office

14 Capo D'Orlando Drive,
South Fremantle WA 6162
08 9432 8000

Geraldton Office

69-75 Connell Road,
Geraldton WA 6530
08 9920 8400

Hillarys Office

39 Northside Drive,
Hillarys WA 6025
08 9203 0111

Mandurah Office

107 Breakwater Parade,
Mandurah Ocean Marina,
Mandurah WA 6210
08 9583 7800

dpird.wa.gov.au

ABN: 18 951 343 745

FISHWATCH



REPORT
▶ Illegal fishing
▶ Pests and diseases
▶ Fish kills

1800-815-507
24 HOUR REPORTING



Scan to
report online